



02-03 1
LED LIGHT BAR AND BUMPER
WITH DAYTIME RUN LIGHTS
WILL FIT CLUB CAR® PRECEDENT®
INSTALLATION INSTRUCTIONS

INCLUDED:

- LED light bar and bumper
- 2 LED Tail Lights
- 1 Headlight Harness
- 8 Screws
- Straps
- Rocker Switch
- Fuse Assembly

TOOLS NEEDED:

- #2 Phillips Bit
- Cutting Tool
- Sandpaper
- Power Drill
- 15/32 Drill Bit
- 10mm Socket
- 13mm Wrench
- Ratchet
- 1 1/2" Hole Saw



LED Light Bar



Headlight
Harness



Fuse Assembly

DAYTIME RUN LIGHTS SPECIAL INSTRUCTIONS: For 2008.5 and newer: If you are going to be using the daytime run light feature refer to special steps in your bucket harness instructions. If your bucket harness instructions do not have special steps download new instructions from our website. For carts 2008.5 and older you will need to add a bucket harness to make this feature work.

Madjax recommends professional installation. If you choose to not have this product installed by a professional, we highly recommend that you exercise caution, care, and patience when installing this product as it involves drilling holes into your cart's body.

There are optional daytime runlights in the LED headlights. For instructions on how to utilize this feature refer to STEP 8.

Remove factory bumper by removing the two factory bolts located in the frame. *Retain hardware

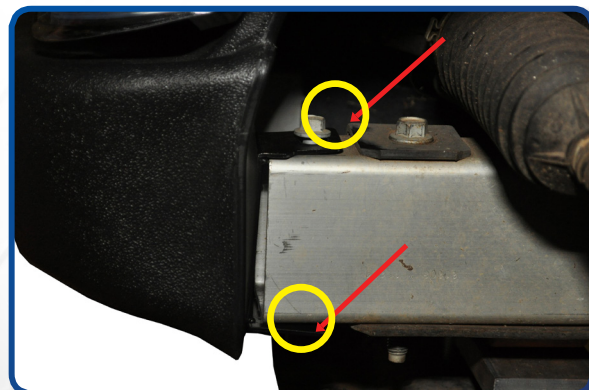

Place Madjax LED light kit bumper on the frame as shown. Light Kit bracket should be placed over the top and under the bottom of frame and flush to front fascia. Attach light using hardware retained from step one.

Remove the 3 console screws as shown and retain hardware.

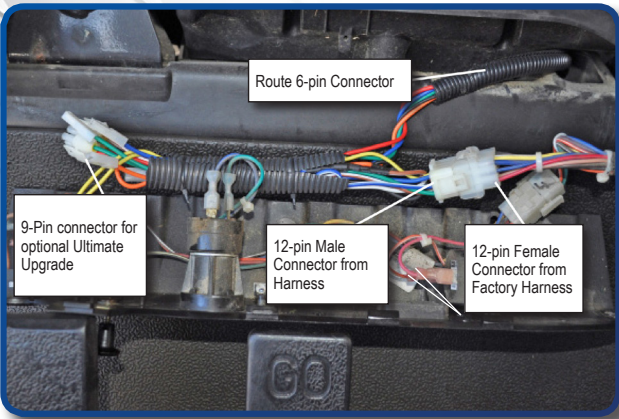

Attach light kit harness to factory harness as shown. For Club Car Precedent 2008+ and up, you will need to install your MJLKBH1000 before proceeding. Follow MJLKBH1000 instructions for installation. *Do not reattach your dashboard*

Locate the indentation to the right of the key switch on the instrument panel and drill a 15/32" hole for the rocker switch. Push switch into drilled hole and tighten with mounting nut.



Earth - Ground (black)
Load - 12v(+) switched (brown)
Supply - 12v(+) constant (yellow)

Attach harness to rocker switch as shown. And then re-attach dashboard using hardware retained from Step 3.

Route the 6 pin headlight connector through the cutout in the passenger dash. Plug the 6 pin male wire harness connector into the 6 pin female headlight wire harness connector and wire tie harness to frame support (the two extra wires on this harness are for use with the optional horn kit).



NOTE: If you wish to run daytime lights a MJ1230 Convertor will be needed to operate them through your keyswitch. If you do not, the daytime run lights will still come on with your headlights and you can skip to STEP 11.

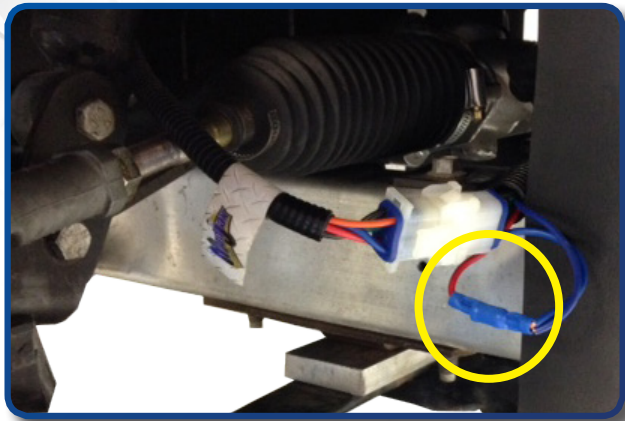

Unplug bullet connector's on light bar side of 6 pin connector as shown.

Locate the labeled Dayrun Light wire, and using 16-18 AWG wire attach it to red accessory wire from 1230C.

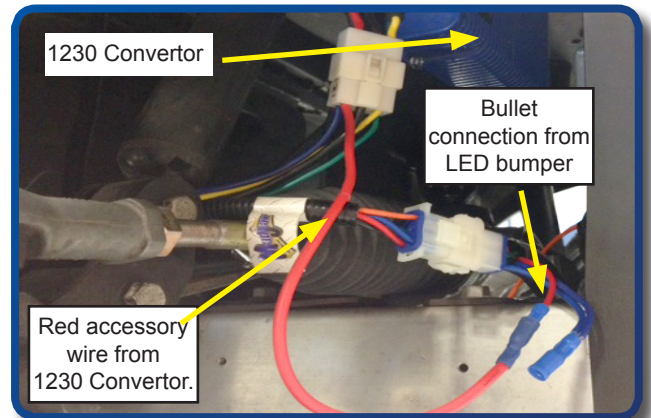

When you turn on the key switch the daytime run lights will now come on. They will stay on when you turn on the headlights and will only turn off when the keyswitch is off.

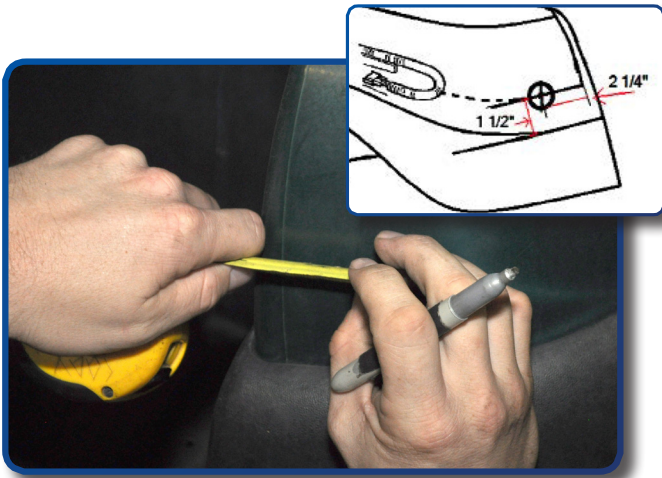

Before removing double sided tape and installing the LED Tail Lights, test fit them in their position on the rear location of the vehicle. Mark the center of the tailight hole using drawing Using a 1-1/2 inch hole saw, drill a hole in the location as shown in drawing 1 . Sand to remove sharp edges.

Position the tail lights as shown in the picture. The flat ends of the tail lights should be where the sharper curve of the body from the bag well begins a more gradual curve. If there is a gap between the tail light and the body, reposition until there is no gap. Thoroughly clean the surface area where tail lights will be mounted. *Important: Surface must be free of any dirt, wax, or products that will inhibit double sided tape from adhering properly.



Using a wire snake, pull the tail light connector through the hole in the rear body. Connect the tail lights to the vehicle tail light wiring harness. Determine the desired location of the tail lights. Remove the double sided tape from the back of the tail light and mount to the rear body.

NOTE: Fuse assembly will not be used when installing a Madjax Bucket Harness.

PICTURE 3

FUSE ASSEMBLY INSTALLATION

(For gas vehicles, please see MJGH1000 Sub harness Installation Instructions.)

12 Volt Battery Installation (for vehicles without DC to DC converter)

1. Remove the seat bottom and the electronic component cover located between the batteries.
2. Locate the blue wire leading from the #4 battery positive connection and connect to the long lead of the fuse assembly.
3. Locate the single 12 gauge blue wire with a spade terminal leading from the passenger side of the electronic component area and connect the short lead leading from the fuse assembly.
4. Secure all loose wires.
5. Replace the electronic component cover and test the lights.

For vehicles with 8 volt batteries you must use a DC to DC converter

**We recommend the use of either MADJAX part #'s
MJ1230C MJ1612VR**

Follow the instructions supplied with you converter for the following steps. We recommend the use of a multi-meter to check the voltage for 12V + before light kit is turned on to ensure your converter is working properly.

- 1) The Ground or negative wire is located at the rear of the battery box behind battery #3. It is a black wire with a female bullet connector.
- 2) The 16 volt positive connection (SEE PICTURE 4) is located on Battery #3. It is a short blue wire with a spade terminal. It is located on the negative terminal as illustrated in the picture. This connection is used in conjunction with a 16volt to 12volt If there is no short blue wire you will need to use a ring terminal here.
- 3) The 48volt + (positive) connection is located on battery #6 as shown. It is the short blue wire with spade terminal. **ONLY USE THIS CONNECTION IN CONJUNCTION WITH A 48 VOLT TO 12 VOLT REDUCER/CONVERTER OR BULB FAILURE WILL RESULT!!**

Once you have your converter hooked up. The Blue wire on the bucket harness will connect to the 12 Volt output from the convertor and the Black wire from the bucket harness will attach to the main battery pack negative.

Always Verify voltage before turning on lights

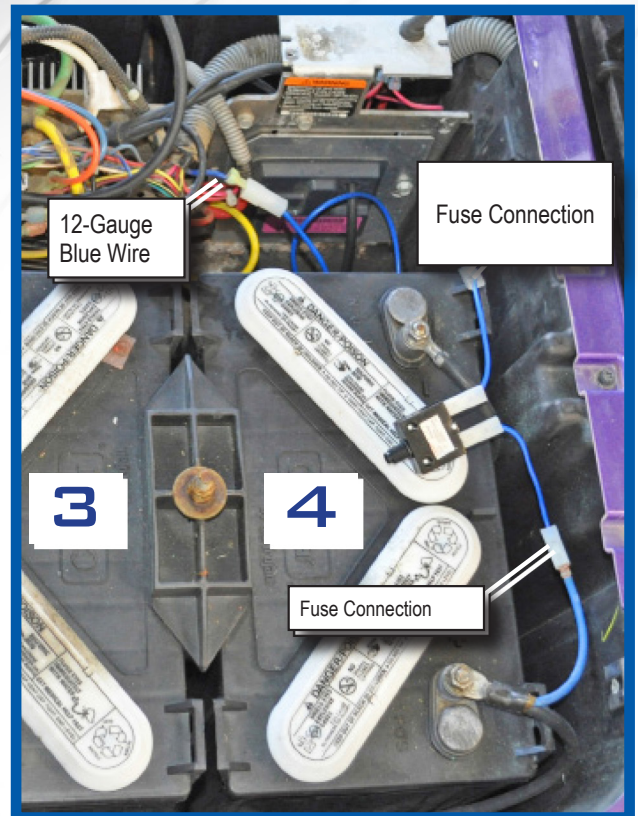

FRONT OF CART

PICTURE 4

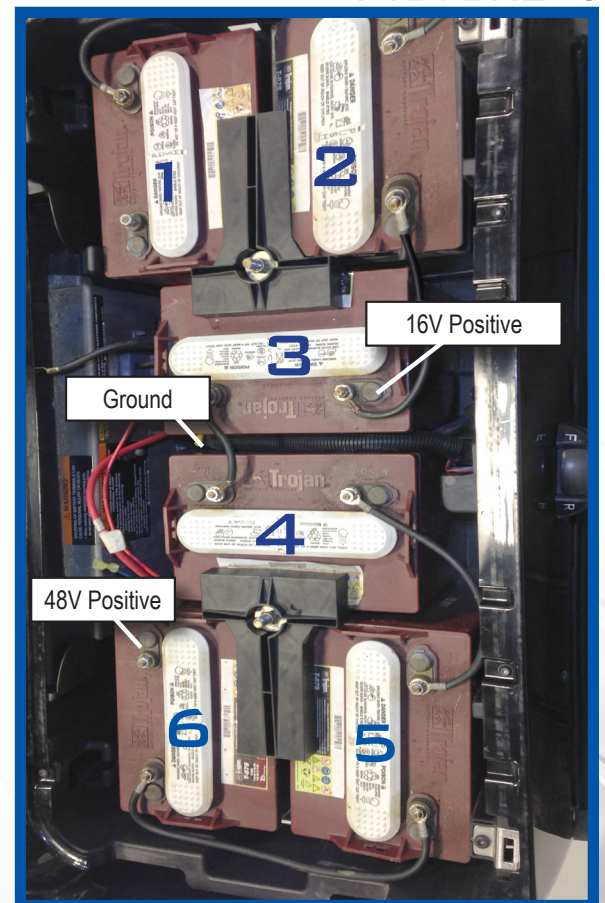

FRONT OF CART

PRECEDENT MAIN HARNESS

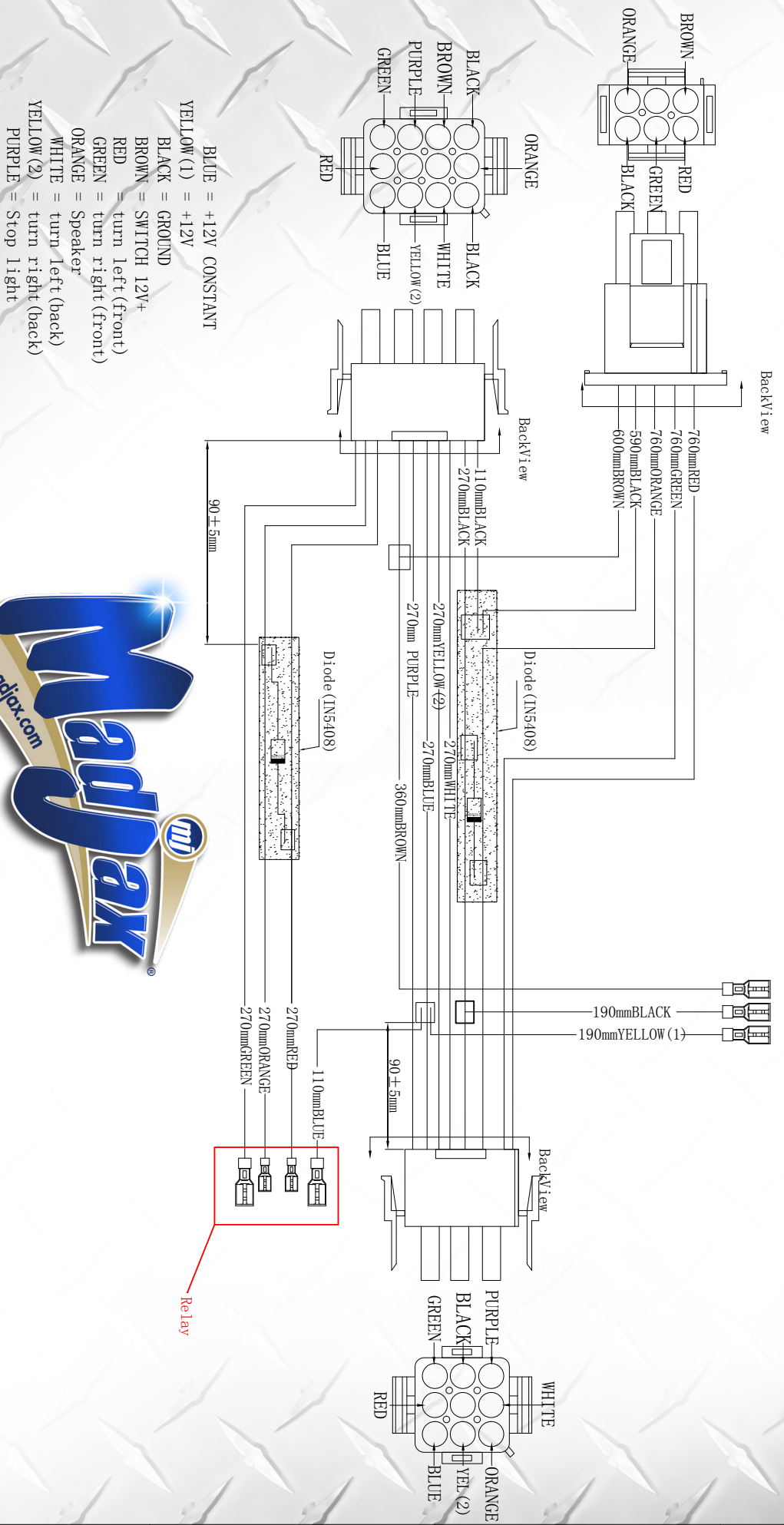

- BLUE = +12V CONSTANT
- YELLOW (1) = +12V
- BLACK = GROUND
- BROWN = SWITCH 12V+
- RED = turn left (front)
- GREEN = turn right (front)
- ORANGE = Speaker
- WHITE = turn left (back)
- YELLOW (2) = turn right (back)
- PURPLE = Stop light



1 2 3 4 5

A B C D

A B C D

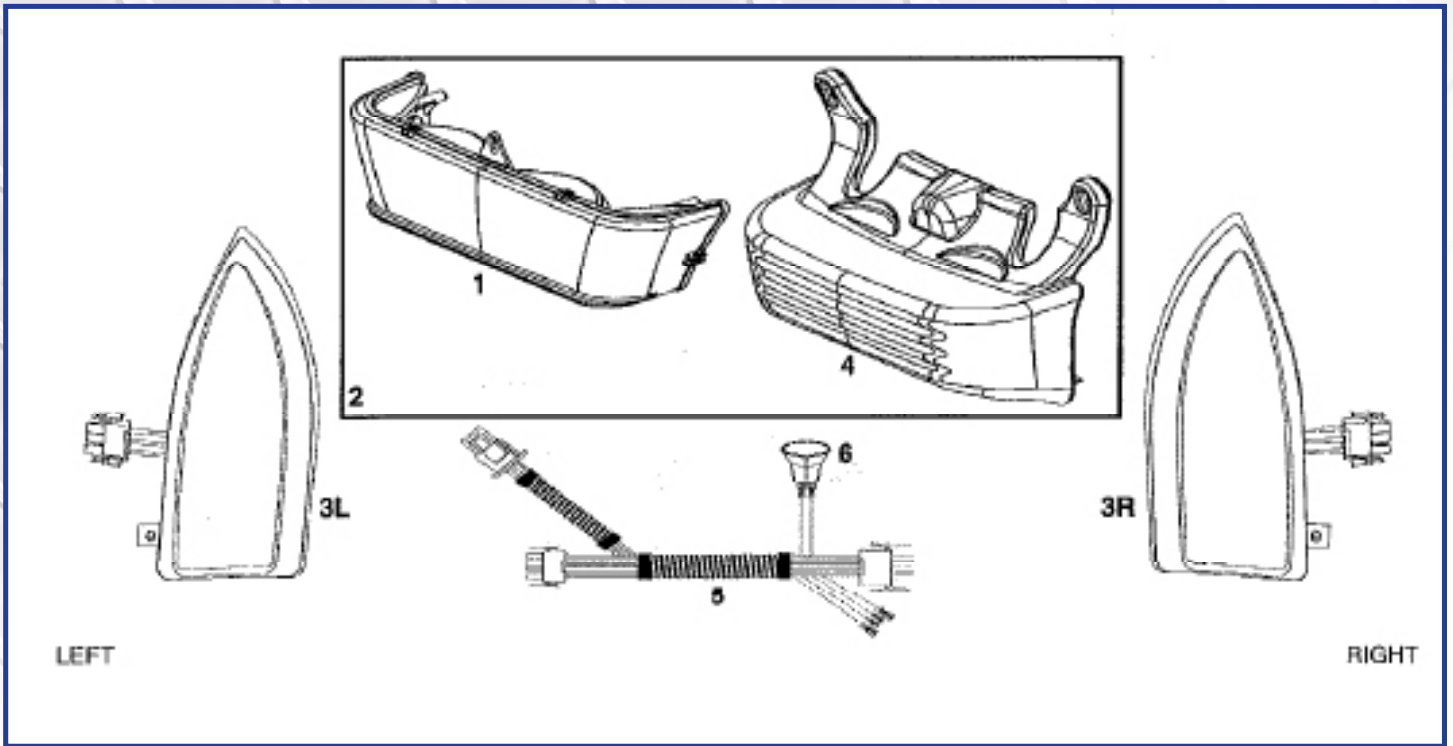

INSTALLATION COMPLETE

VISIT WWW.MYMADJAX.COM FOR MORE INSTALLATION VIDEOS.

Club Car®, Club Car® Precedent®, and Club Car® DS® are registered trademarks of Ingersoll Rand, Inc. (“Ingersoll Rand”). Reference to Club Car®, Club Car® Precedent®, or Club Car® DS® or any of Ingersoll Rand’s trademarks, word marks, or products is only for purposes of identifying golf carts with which this Madjax product is compatible. Madjax products are aftermarket parts and are not original equipment parts. Madjax is not connected to, affiliated with, sponsored by, or endorsed by Ingersoll Rand or any of its subsidiary companies.

